

planning guide



clever thinking

KITSET
KITCHENS

getting started

This planning guide provides you with everything you need to create a draft kitchen plan and receive a quotation.

The simple four-step process is as follows:

1. measure up

- Measure the room
- Note service points
- Sketch measurements on graph paper

2. draft your plan

- Determine the shape
- Select cabinets
- Consider panels & infills
- Complete draft plan

3. final touches

- Doors
- Benchtops
- Handles
- Colours

4. next steps

- Quote
- Order
- Confirmation
- Take delivery
- Assemble and install





1. measure up

Measuring the space you have available for your kitchen is a simple but important task that needs to be completed accurately. You will need a tape measure, a pencil (and eraser!) and the graph paper provided on the back of this Planning Guide.

measure the room

Measure the length, width and height of your room and note the size and location of all windows and doors. Ignore existing cabinets and take care to measure any doors and windows to the outside of the architraves.

note:

Take measurements of the precise location of service points such as plumbing, gas fittings and electricity.

sketch measurements on graph paper

Using the measurements of the room and service points that you have just taken, sketch them onto the graph paper provided.

note:

1 square on the graph paper = 10 cm

10 squares on the graph paper = 1 metre

An example of a completed draft plan is shown on page 12.

2. draft your plan

Now that you've measured the size of the space you have available, it's time to determine the shape of the kitchen that will best suit. You will then select the cabinets that you'd like to include and prepare a draft plan of your new kitchen.

determine the shape

Use the following examples to determine the kitchen shape that best suits the space you have available.

select cabinets

It's now time to select the cabinets that you would like to include in your kitchen. Refer to the cabinets listed on the following six pages and think about how you'd like to arrange them in your kitchen.

You can then start to sketch them on the graph paper like the example on page 12.

kitset's 10 layout tips

Here are some handy tips to take into consideration when working on the design of your kitchen.

1. Plan the sink & dishwasher close to each other.
2. Incorporate a waste disposal cabinet close to the sink area.
3. Keep at least 300mm on each side of the cooktop for utensils and clearance for saucepan handles.
4. Plan your fridge on the outer limits of your kitchen to enable access without entering the work zone.
5. Microwaves are hinged on their left, so should be positioned in a left corner to enable easy access.
6. Make sure the doors of your dishwasher & oven do not open into the same place.
7. Walkways should be a minimum of 800mm wide and a maximum of 1200mm wide.
8. Plan clear, short distances between your sink, cooking area & fridge - totalling no more than 7 metres.
9. Make sure you have thought about a pantry and cutlery drawer.
10. Drawers may be more expensive than doors but they offer easier access to storage space.

straight

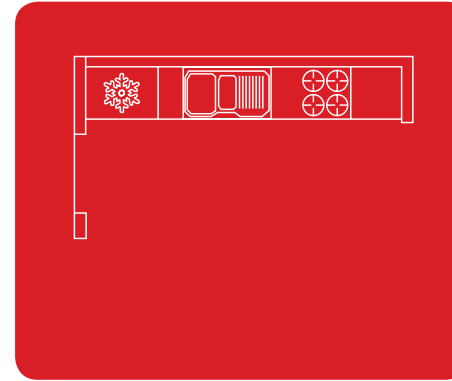

Straight layouts are a single row of cabinets and tend to work best for small basic kitchens in small homes or units.

galley

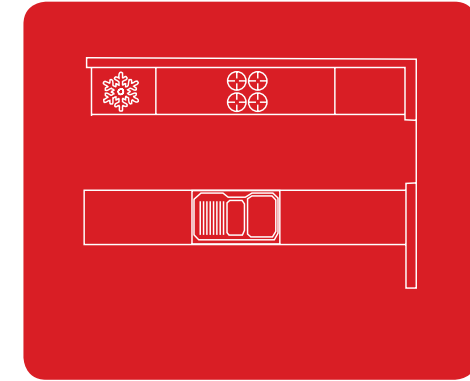

The Galley design features two rows of cabinets with a walkway through the middle, which is ideal for kitchens with limited space. A raised bar can be added to the second row if you wish.

L - shaped

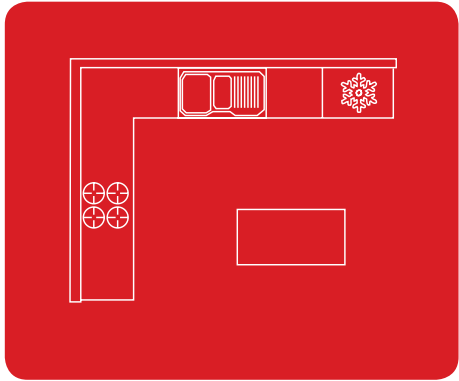

This design is perfect for utilising the corner of a room and is generally larger than Straight or Galley layouts. You can also incorporate an island bench or dining table in the centre as shown.

U - shaped

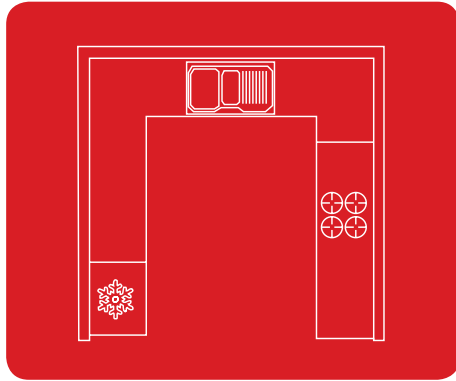

The U-Shaped layout comprises of cabinets on three sides of the room. This layout requires a larger area, but provides the most flexible design.

U - shaped variation

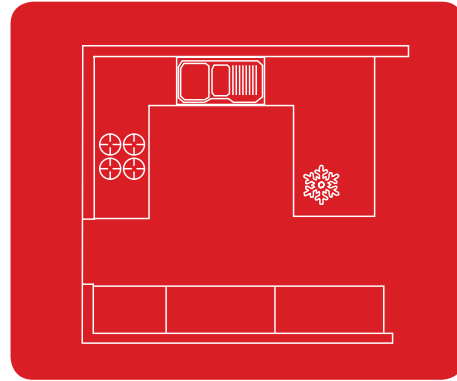

Think of this layout as a cross between a Galley and a standard U-Shape. It allows for a walkway, cabinets on all four sides with additional storage facilities.

open plan

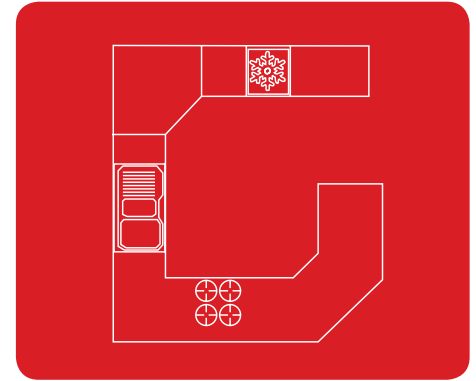

This layout makes your kitchen form part of a much larger room. It allows for an open bench or raised bar on two sides.

cabinet sizes & kitchen height

The Kitset system gives you the flexibility to pick the overall height of your kitchen from three options:

- tall**
- medium**
- standard**

The diagram on the right shows the heights of the cabinets in each of the available options.

As all Kitset cabinetry is manufactured to suit your available space, we are able to customise the widths of cabinets where necessary.

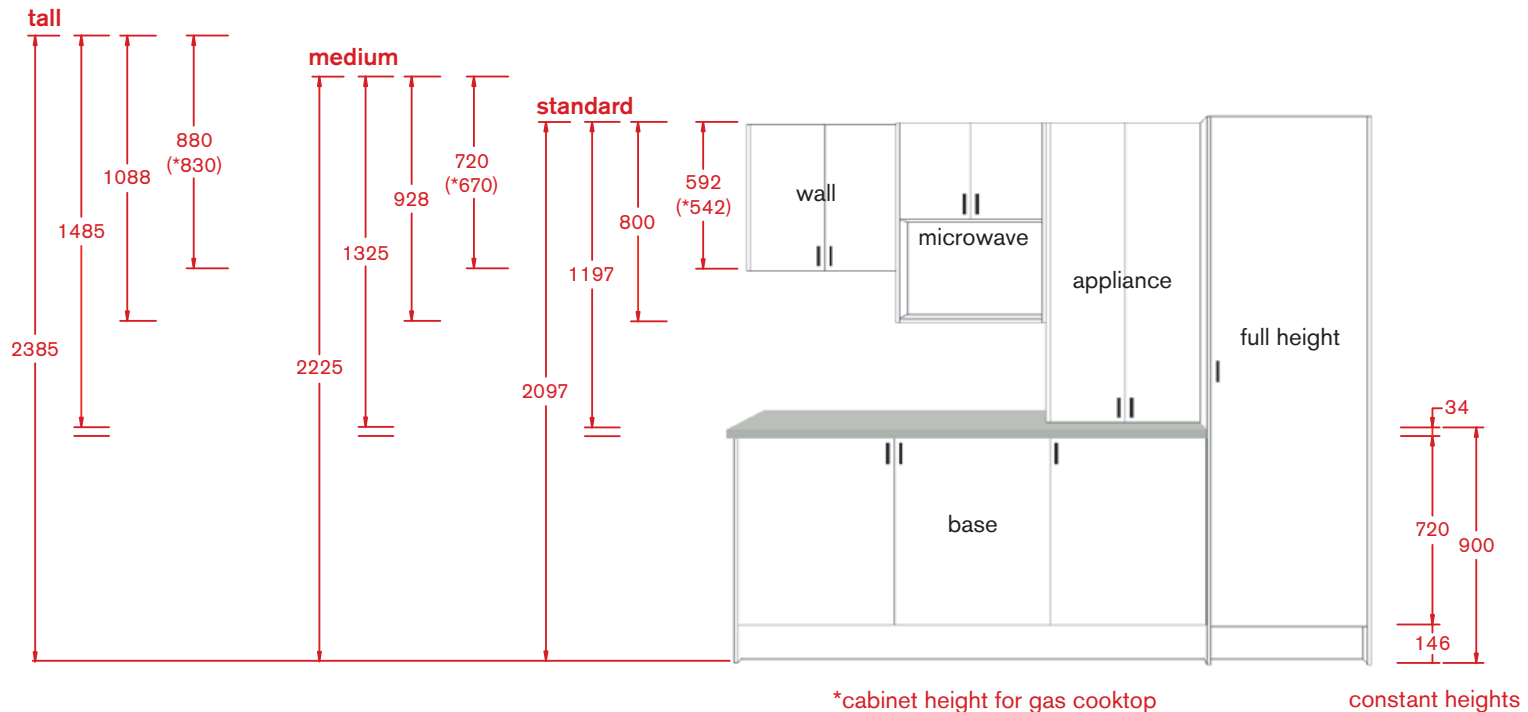







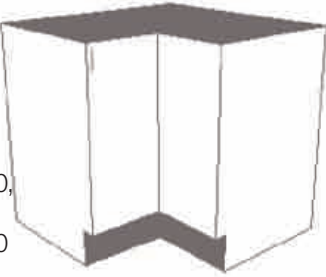
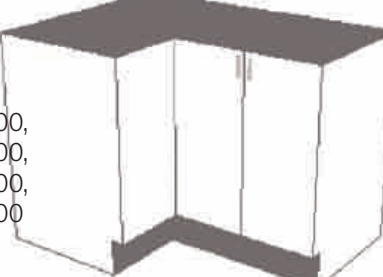
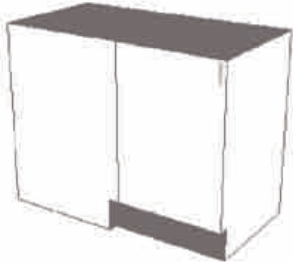

*cabinet height for gas cooktop

constant heights

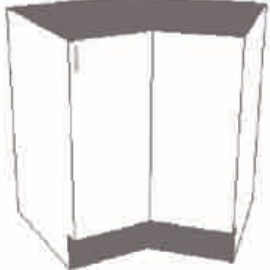
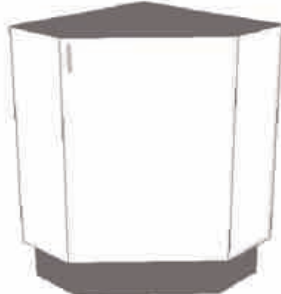
cabinets

base cabinets

B1	B2	BC-2	BC-3
<p>Base cabinet with one door.</p> <p>depth 580</p> <p>height 900</p> <p>widths 150*, 200*, 250*, 300, 350, 400, 450, 500, 550, 600</p> 	<p>Base cabinet with two doors.</p> <p>depth 580</p> <p>height 900</p> <p>widths 600, 650, 700, 750, 800, 850, 900, 950, 1000, 1050, 1100, 1150, 1200</p> 	<p>Base corner cabinet with two doors.</p> <p>depth 580</p> <p>height 900</p> <p>widths 800x800, 800x900, 800x1000, 900x900, 900x1000</p> 	<p>Base corner cabinet with three doors.</p> <p>depth 580</p> <p>height 900</p> <p>widths 800x1100, 800x1200, 900x1100, 900x1200</p> 
BL-1	BL-2	B45	BCA
<p>Blind base cabinet with one door.</p> <p>depth 580</p> <p>height 900</p> <p>widths 1000, 1050, 1100, 1150, 1200.</p> 	<p>Blind base cabinet with two doors.</p> <p>depth 580</p> <p>height 900</p> <p>widths 1100, 1150, 1200</p> 	<p>45° Base cabinet.</p> <p>depth 580</p> <p>height 900</p> <p>widths 550x550</p> 	<p>Base angled corner cabinet.</p> <p>depth 580</p> <p>height 900</p> <p>width 580</p> 
BD-4	BD-3	BD-3P	BD2C1P
<p>Four cutlery drawers.</p> <p>depth 580</p> <p>height 900</p> <p>widths 400, 450, 500, 550, 600</p> 	<p>Three equal drawers.</p> <p>depth 580</p> <p>height 900</p> <p>widths 600, 650, 700, 750, 800, 850, 900</p> 	<p>One cutlery drawer & two pot drawers.</p> <p>depth 580</p> <p>height 900</p> <p>widths 600, 650, 700, 750, 800, 850, 900</p> 	<p>Two cutlery drawers over one pot drawer.</p> <p>depth 580</p> <p>height 900</p> <p>widths 500, 550, 600, 650, 700</p> 

Note: Cabinet sizes and styles may change without notice. Base cabinet height includes benchtop & kickrail.

BD-22

Two cutlery drawers side by side over two pot drawers.

depth 580

height 900

widths 700, 750, 800, 850, 900, 950, 1000



BD-2

Two pot drawers.

depth 580

height 900

widths 600, 650, 700, 750, 800, 850, 900



BDB-2

Integrated bin drawer over one pot drawer.

depth 580

height 900

width 400



BDD-1

One cutlery drawer over one door.

depth 580

height 900

widths 350, 400, 450, 500, 550, 600



BDD-2

Two cutlery drawers side by side over two doors.

depth 580

height 900

widths 700, 750, 800, 850, 900, 950, 1000, 1050, 1100, 1150, 1200



BDD-12

One cutlery drawer over two doors.

depth 580

height 900

widths 600, 650, 700, 750, 800, 850, 900



BMW

Base cabinet with microwave space over one pot drawer.

depth 580

height 900

widths 600, 650, 700



DW-1

Pot drawer for under Fisher & Paykel single Dish Drawer.

depth 580

height 900 (to top of benchtop, height includes dishwasher)

width 600



UBO

Under bench oven cabinet. Suits most under bench ovens.

depth 580

height 900

widths 600, 700, 800, 900



UBO-D

Under bench oven cabinet with drawer. Suits most under bench ovens.

depth 580

height 900

widths 600, 700



UBO-P

Under bench oven cabinet with pot drawer. Suits under bench ovens less than 600mm high.

depth 580

height 900

widths 800, 900



REV-B1

Base cabinet with one door for placement on the reverse side of an island, next to a wall.

depth 580

height 900

width 600



*Not available in selected door styles.

BD-L

Laundry drawer.

depth 580

height 900

widths 500, 550, 600

**BOS**

Base open shelf cabinet.

depth 280, 380, 480, 580

height 900

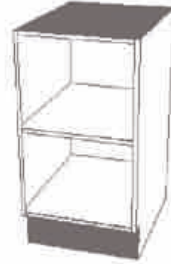
widths 150, 200, 250,
300, 350, 400,
450, 500, 550,
600, 650, 700,
750, 800, 850,
900**BAO**

Base angled open shelf cabinet.

depth 580

height 900

width 300

**BWR**

Base wine rack.

depth 320

height 900

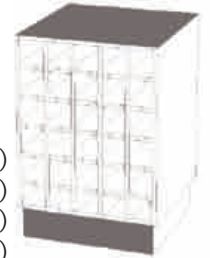
widths 150 (1 bottle wide)
250 (2 bottles wide)
350 (3 bottles wide)
450 (4 bottles wide)
550 (5 bottles wide)**W-1**

Wall cabinet with one door.

depth 320

height 542, 592, 670,
720, 830, 880widths 200*, 250*, 300,
350, 400, 450,
500, 550, 600**W-2**

Wall cabinet with two doors.

depth 320, 400, 450

height 542, 592, 670,
720, 830, 880widths 600, 650, 700,
750, 800, 850,
900**WC-2**

Wall corner cabinet.

depth 320

height 542, 592, 670,
720, 830, 880

widths 600X600

**WBC-1**

Blind wall cabinet with one door.

depth 320

height 542, 592, 670,
720, 830, 880widths 600, 650, 700,
750, 800, 850,
900**WBC-2**

Blind wall cabinet with two doors.

depth 320

height 542, 592, 670,
720, 830, 880widths 800*, 850*, 900,
950, 1000,
1050, 1100,
1150, 1200**W45**

45° wall cabinet.

depth 580

height 542, 592, 670,
720, 830, 880

widths 550x550

**WLU**

Wall cabinet with a lift-up door.

depth 320

height 400

widths 500, 550, 600,
650, 700, 750,
800, 850, 900**RHSL**

Cabinet for a slide-out rangehood.

depth 320

height Variable to suit
rangehood/
hotplates.

widths 600, 900



Note: Cabinet sizes and styles may change without notice.

WOS

Wall open shelf cabinet.

depth 320

height 542, 592, 670,
720, 830, 880

widths 200, 250, 300,
350, 400, 450,
500, 550, 600,
650, 700, 750,
800, 850, 900



WAO

Wall angled open shelf cabinet.

depth 320

height 542, 592,
670, 720,
830, 880

width 300



WWR

Wall wine rack.

depth 320

height 542, 592, 670,
720, 830, 880

widths 150 (1 bottle wide)
250 (2 bottles wide)
350 (3 bottles wide)
450 (4 bottles wide)
550 (5 bottles wide)



WMW

Wall microwave cabinet.

depth 400, 450

height 800, 928, 1088

widths 600, 650, 700



microwave cabinets

AP1

Appliance cabinet with one door.

depth 320, 400, 450

height 1197, 1325, 1485

widths 200*, 250*, 300,
350, 400, 450,
500, 550, 600



AP2

Appliance cabinet with two doors.

depth 320, 400, 450

height 1197, 1325, 1485

widths 600, 650, 700,
750, 800, 850,
900



AP-2BI

Appliance cabinet with one bi-fold door.

depth 320, 400, 450

height 1197, 1325, 1485

widths 600, 650, 700,
750, 800, 850,
900



AP-4BI

Appliance cabinet with two bi-fold doors.

depth 320, 400, 450

height 1197, 1325, 1485

widths 800*, 850*, 900*,
950*, 1000*, 1050*,
1100, 1150, 1200



APOS

Open shelf appliance cabinet.

depth 320, 400, 450

height 1197, 1325, 1485

widths 600, 650, 700,
750, 800, 850,
900



APR40

Appliance cabinet with 450mm high rollerdoor.

depth 320, 400, 450

height 1197, 1325, 1485

widths 600, 650, 700,
750, 800, 850,
900



APR60

Appliance cabinet with 605mm high rollerdoor.

depth 320, 400, 450

height 1197, 1325, 1485

widths 600, 650, 700,
750, 800, 850,
900



APR65

Appliance cabinet with 655mm high rollerdoor.

depth 320, 400, 450

height 1197, 1325, 1485

widths 600, 650, 700,
750, 800, 850,
900



*Not available in selected door styles.

APMW

Appliance cabinet with rollerdoor and microwave space.

depth 400, 450.

height 1197, 1325, 1485

widths 600, 650, 700



full height cabinets

P-1

Pantry with one door.

depth 600

height 2097, 2225, 2385

widths 350, 400, 450,
500, 550, 600



P-2

Pantry with two doors.

depth 600

height 2097, 2225,
2385

widths 600, 650, 700,
750, 800, 850,
900, 950, 1000



PD-3

Pantry with three pot drawers.

depth 600

height 2097, 2225, 2385

widths 600, 650, 700,
750, 800, 850,
900, 950, 1000



PD-3P

Pantry with one cutlery drawer and two pot drawers.

depth 600.

height 2097, 2225,
2385

widths 600, 650, 700,
750, 800, 850,
900, 950, 1000



PD-2P

Pantry with two pot drawers.

depth 600

height 2097, 2225, 2385

widths 600, 650, 700,
750, 800, 850,
900, 950, 1000



POP

Pull-out Pantry.

depth 600

height 2097, 2225,
2385

widths 300, 400



PBLS-1

Blind pantry cabinet.

depth 600

height 2097, 2225, 2385

widths 1000, 1050,
1100, 1150,
1200



WIP-1

Walk-in pantry with one door.

depth 600

height 2097, 2225, 2385

widths 900x900,
1000x1000



BR-1

Broom cabinet with one door.

depth 600

height 2097, 2225, 2385

widths 350, 400, 450,
500, 550, 600



BR-2

Broom cabinet with two doors.

depth 600

height 2097, 2225, 2385

widths 600, 650, 700,
750, 800, 850,
900, 950, 1000



FOC

Cabinet for over a fridge
(panels not included).

depth 600

height 2097, 2225, 2385
Cavity variable to suit fridge
height.

widths 600, 650, 700,
750, 800, 850,
900



Note: Cabinet sizes and styles may change without notice.

Full and half depth shelving options available.

OVS-23

Oven tower with three pot drawers.

depth 600

height 2097, 2225, 2385
Pot drawers 240 high each, oven cavity variable.

width 632, 932



OVS-22

Oven tower with two pot drawers.

depth 600

height 2097, 2225, 2385
Pot drawers 240 high each, oven cavity variable.

width 632



OVS-22P

Oven tower with two pot drawers.

depth 600

height 2097, 2225, 2385
Pot drawers 270 high each, oven cavity variable.

width 632



OVS-21

Oven tower with one pot drawer.

depth 600

height 2097, 2225, 2385
Pot drawer 360 high, oven cavity variable.

width 632



OVSMW-23

Oven tower with microwave space and three pot drawers.

depth 600

height 2097, 2225, 2385
Pot drawers 240 high each, oven cavity max 480.

width 932



OVSMW-22

Oven tower with microwave space and two pot drawers.

depth 600

height 2097, 2225, 2385.
Pot drawers 240 high each, oven cavity max 600

width 632



OVSMW-22P

Oven tower with microwave space and two pot drawers.

depth 600

height 2097, 2225, 2385.
Pot drawers 270 high each, oven cavity max 600

width 632



OVSMW-21

Oven tower with microwave space and one pot drawer.

depth 600

height 2097, 2225, 2385
Pot drawer 360 high, oven cavity max 900.

width 632



P-O

Tall open shelf cabinet.

depth 600, 320

height 2097, 2225, 2385

widths 300, 350, 400, 450, 500, 550, 600, 650, 700, 750, 800, 850, 900



TAO

Tall angled open shelf cabinet.

depth 600

height 2097, 2225, 2385

width 300



TWR

Tall wine rack.

depth 320

height 2097, 2225, 2385

widths 150 (1 bottle wide)
250 (2 bottles wide)



*Not available in selected door styles.

consider panels, infills and kickrails

When we receive your draft plan we will always make allowances for the necessary panels, infills and kickrails required. You can help us in that process by marking any exposed ends or backs of cabinets with an arrow symbol ► as they will require panels. Any cabinets that sit against a wall can be marked with a block symbol ■ as they will require infills.

The use of these symbols is shown on the completed draft plan example on the following page.

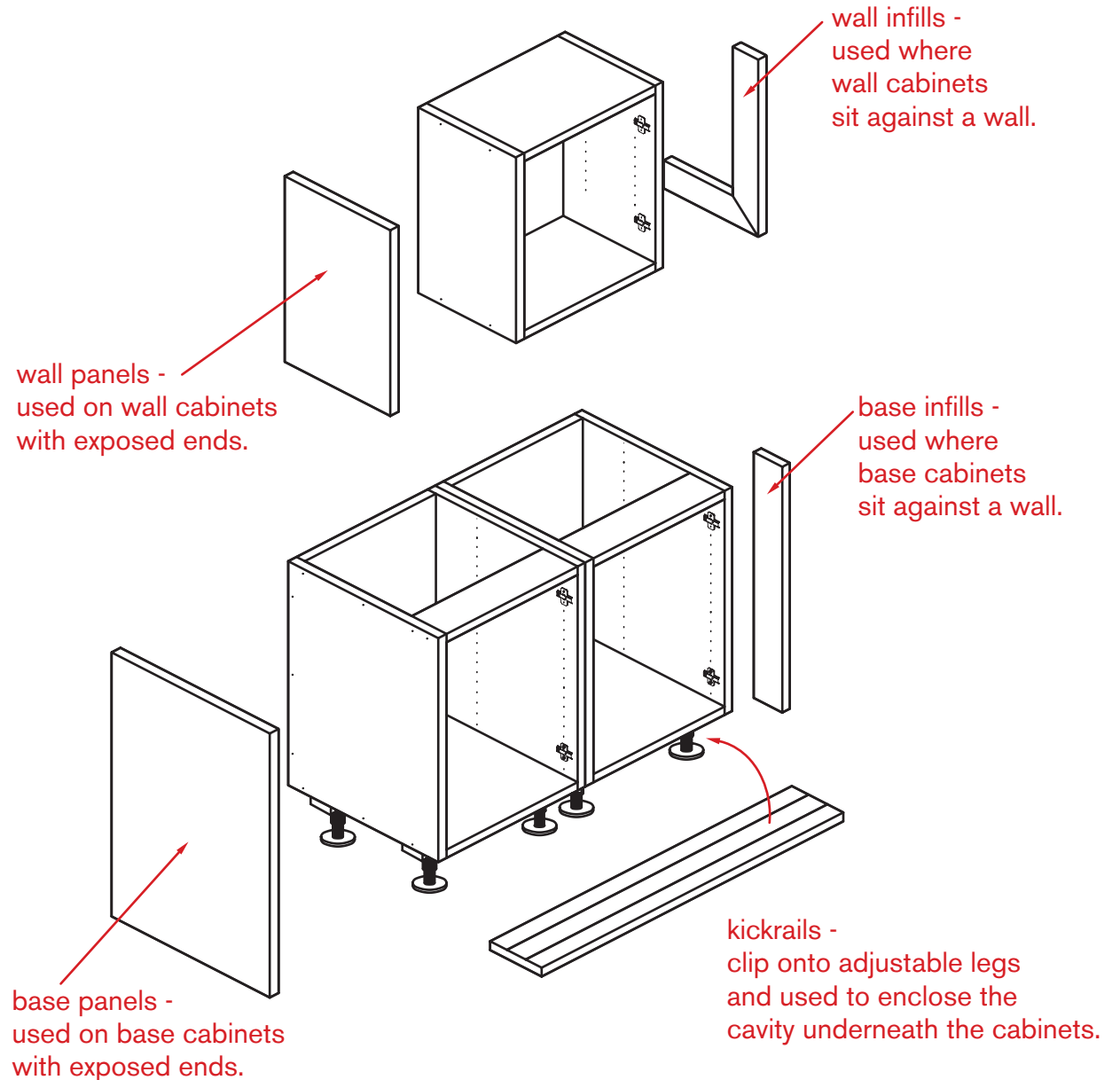

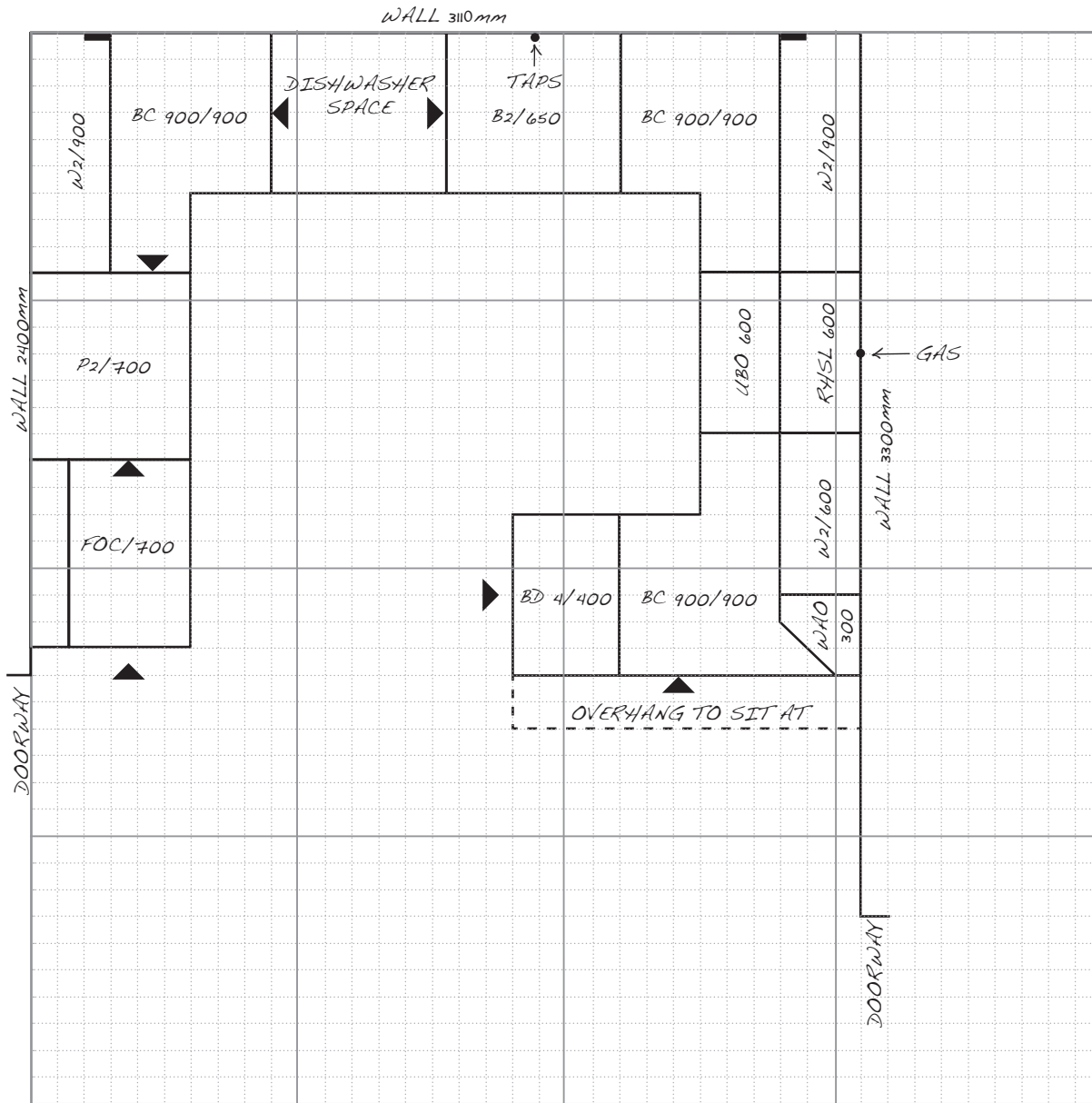

complete draft plan

By now, your draft plan should look something like this example and will include:

- Room measurements
- Service points
- Layout of your cabinets
- Location of panels and infills

Don't worry if your plan doesn't look as complete as our example, we're very experienced at interpreting plans and our staff are more than happy to assist you in completing it.

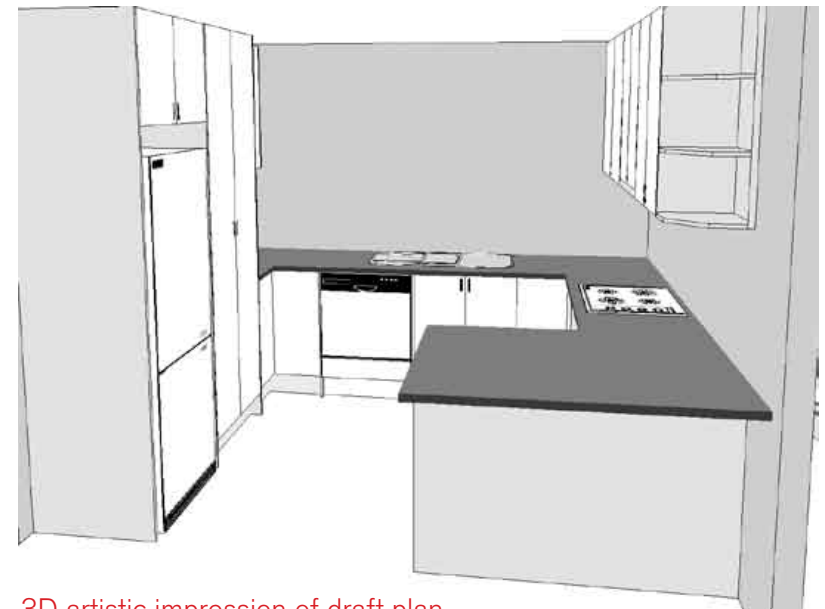

3D artistic impression of draft plan

3. final touches

doors

The extensive range of Kitset doors includes options to suit all kitchen styles - from classic to contemporary. Choices for glass doors and aluminium frames are also available.

melamine – matt

Flat-faced, fine-textured melamine doors are a durable and economical choice. They are available in two styles:

tuff-edge

2mm PVC applied to all four edges.

round-edge

Rounded melamine on vertical edges with 2mm PVC applied to horizontal edges.

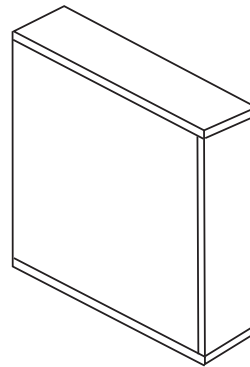

tuff-edge

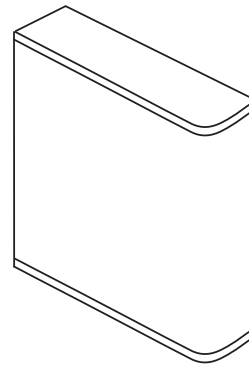

round-edge

melamine – semi-gloss

Flat-faced, semi-gloss melamine doors are a cost-effective means of achieving a lustrous finish. These doors have PVC applied to all four edges and are available in the tuff-edge style.

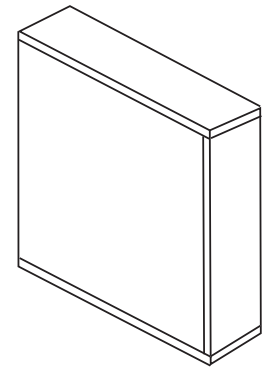

tuff-edge

solid timber

Kitset Solid Timber doors are available in Tasmanian Oak, Blackwood, Redgum and Jarrah. These doors are of extremely high quality and can be supplied either in their raw form or with a clear lacquered finish. They are available in four styles.

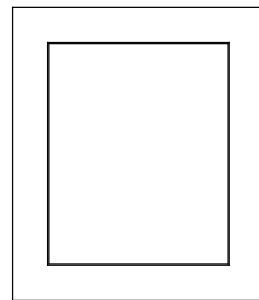

shaker

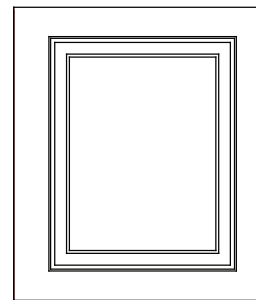

traditional

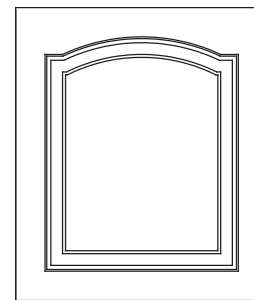

arched

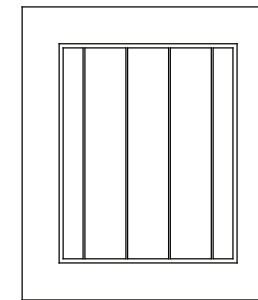

farmhouse



vinyl crystal

Crystal finish doors have a light texture to their vinyl surface. These doors are the most economical vinyl option and are available in six styles.



essence

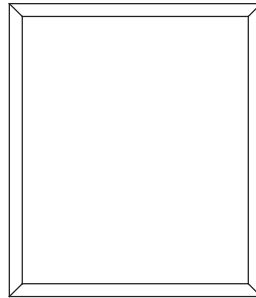
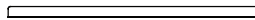

soft-edge

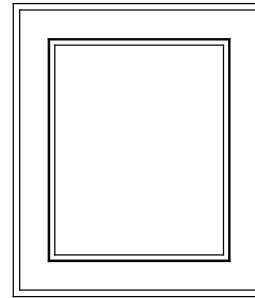
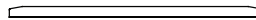

shaker

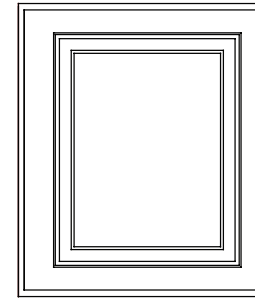

traditional

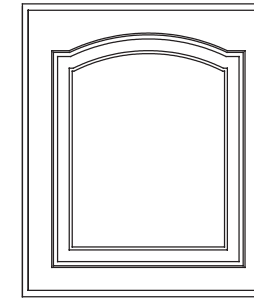
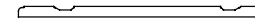

arched

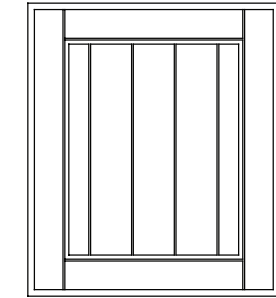
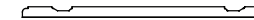

farmhouse



vinyl matt

Matt finish doors have an extremely smooth vinyl surface. These doors are more expensive than the crystal finish and are available in the same six styles.

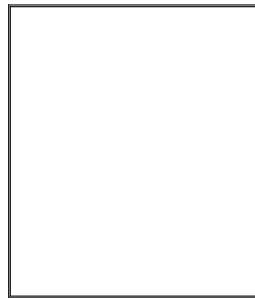

essence

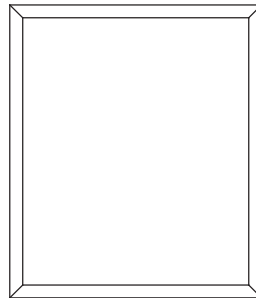
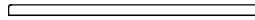

soft-edge

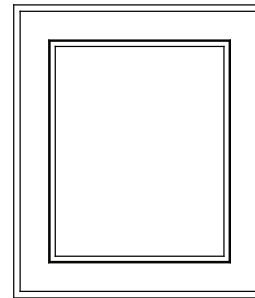
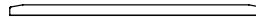

shaker

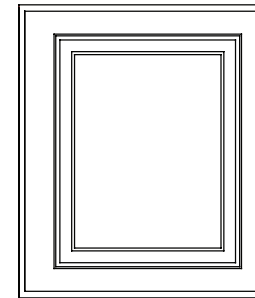
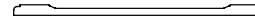

traditional

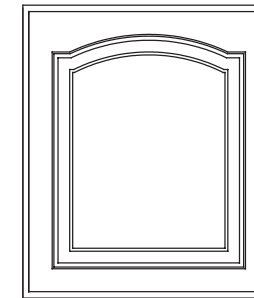
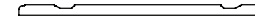

arched

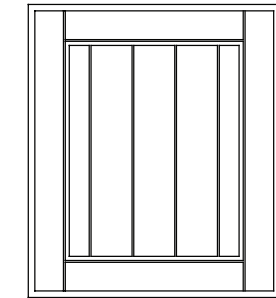
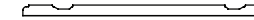

farmhouse



vinyl gloss

Gloss finish doors have a sophisticated, high gloss vinyl surface. These doors are the most expensive of the vinyl options and are available in two simple styles.



essence

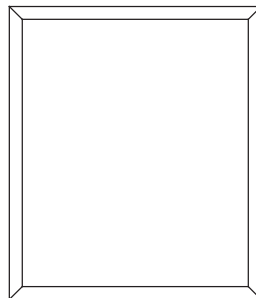
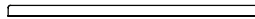

soft-edge

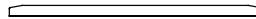

about vinyl

Vinyl doors are manufactured by pressing a durable and easy to clean vinyl sheet onto a preformed MDF core. This process allows the doors to have a profiled face. Vinyl doors are available in Crystal, Matt and Gloss finishes.

benchtops

Kitset benchtops come in a range of styles, types and finishes. These are individually manufactured to suit your kitchen layout.

types

laminated

Laminated benchtops provide a hard wearing surface available in many different textures and colours.

laminated profiles

There are three benchtop profiles to choose from for complementing the style of kitchen.



flat form



round edge



square edge

solid timber

Solid timber benchtops are available in Tasmanian Oak, Blackwood, Redgum and Jarrah, supplied raw or with a clear lacquered finish.

alternative surfaces

We provide a network of reputable industry contacts who can supply you directly with other benchtop surfaces.

handles

The Kitset range of handles includes 15 designs.

mini pull
KS011

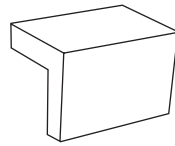

angle pull
KS012

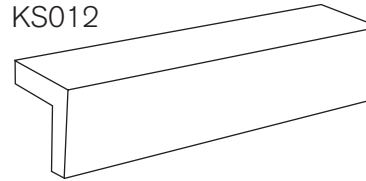

T-bar
KS30

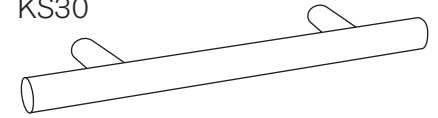

barrel S/C
KS55

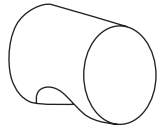

footy S/C
KS50

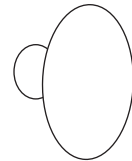

C-pull S/C
KS40



D pull S/C
KS20



mushroom polished
KS65

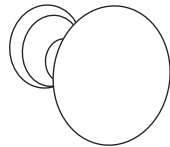

black iron
KS24

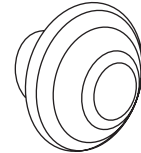

flat C
KS71



flat D pull
KS83

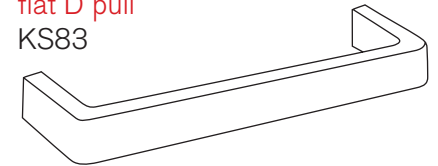

flat mushroom S/C
KS60

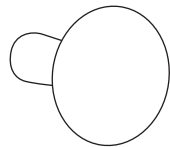

pewter knob
KS85

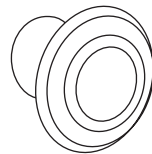

slimline C S/C
KS10



slim D
KS991

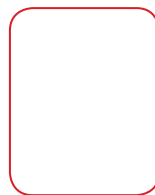
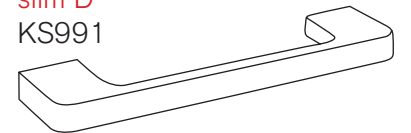

colours

For the Kitset range of door and benchtop colours, please refer to your Kitset colour chart or your nearest showroom. We may also be able to source specific colours from outside our standard range.

4. next steps

Now that you have completed your kitchen draft plan, you have finished the first stage in the Kitset process. The following steps outline what you need to do next.

2. quote

When your kitchen plan is complete, submit it to us for a quote. We can provide extra design assistance after reviewing your plan to make helpful recommendations. Alterations can also be made at this stage to fit with your budget.

3. order

Once the plan and quote are agreed upon, a deposit of 25% is payable on the placement of your order. Appliance details are recorded at this stage.

4. confirmation

A detailed Kitset plan will be prepared and forwarded to you for confirmation. Manufacturing will not commence until this plan has been signed by you and returned.

5. take delivery

Manufacturing will commence after we receive your confirmation, and your kitchen will be ready for pick-up or delivery in 3-4 weeks. Safe and economical delivery can be arranged anywhere in Australia.

6. assemble & install

When you receive your new kitchen, you can assemble and install it using the step-by-step instructions and DVD, or we can recommend a professional installer to complete these tasks for you.



quote request form

Moorabbin
873 Nepean Highway
Moorabbin Vic 3189
phone: 03 9576 5577
fax: 03 9576 5599
moorabbin@kitset.com.au

Thornbury
327 Darebin Road
Thornbury Vic 3071
phone: 03 949 92933
fax: 03 9499 8933
thornbury@kitset.com.au

Ballarat
822 Latrobe Street
Ballarat Vic 3350
phone: 03 5336 3788
fax: 03 5336 3799
ballarat@kitset.com.au

Hamilton
35 Mt Baimbridge Road
Hamilton Vic 3300
phone: 03 557 11337
fax: 03 5572 3302
hamilton@kitset.com.au

name.....
address.....
.....postcode.....

ph: ()..... mob.....
fax..... email.....
send quote by: email fax post

select options for your quote

Kitchen Height Standard <input type="checkbox"/> 2097 mm Medium <input type="checkbox"/> 2225 mm Tall <input type="checkbox"/> 2385 mm			Handles _____									
Doors Melamine - matt <input type="checkbox"/> Tuff-edge <input type="checkbox"/> Round-edge							Melamine - semi-gloss <input type="checkbox"/> Tuff-edge	Solid Timber <input type="checkbox"/> Traditional <input type="checkbox"/> Shaker <input type="checkbox"/> Arched <input type="checkbox"/> Farmhouse	Vinyl - crystal <input type="checkbox"/> Essence <input type="checkbox"/> Soft-edge <input type="checkbox"/> Traditional <input type="checkbox"/> Shaker <input type="checkbox"/> Arched <input type="checkbox"/> Farmhouse	Vinyl - matt <input type="checkbox"/> Essence <input type="checkbox"/> Soft-edge <input type="checkbox"/> Traditional <input type="checkbox"/> Shaker <input type="checkbox"/> Arched <input type="checkbox"/> Farmhouse	Vinyl - gloss <input type="checkbox"/> Essence <input type="checkbox"/> Soft-edge	Colour _____
Benchtops Laminate <input type="checkbox"/> Flatform <input type="checkbox"/> Roundform <input type="checkbox"/> Square Edge			Solid Timber <input type="checkbox"/> Roundform <input type="checkbox"/> Square Edge	Colour _____		Accessories / Additional Notes _____ _____						

Basic Appliance Details Oven <input type="checkbox"/> Underbench <input type="checkbox"/> Freestanding <input type="checkbox"/> Wall					Rangehood <input type="checkbox"/> Slideout <input type="checkbox"/> Fixed <input type="checkbox"/> Canopy	Cooktop <input type="checkbox"/> Gas <input type="checkbox"/> Electric	Dishwasher <input type="checkbox"/> Standard <input type="checkbox"/> Integrated <input type="checkbox"/> Dishdrawer	Fridge Height _____mm Width _____mm
--	--	--	--	--	--	---	--	--

Please quote for:

- Delivery to _____
- Pickup from warehouse

Where did you hear about Kitset Kitchens? _____

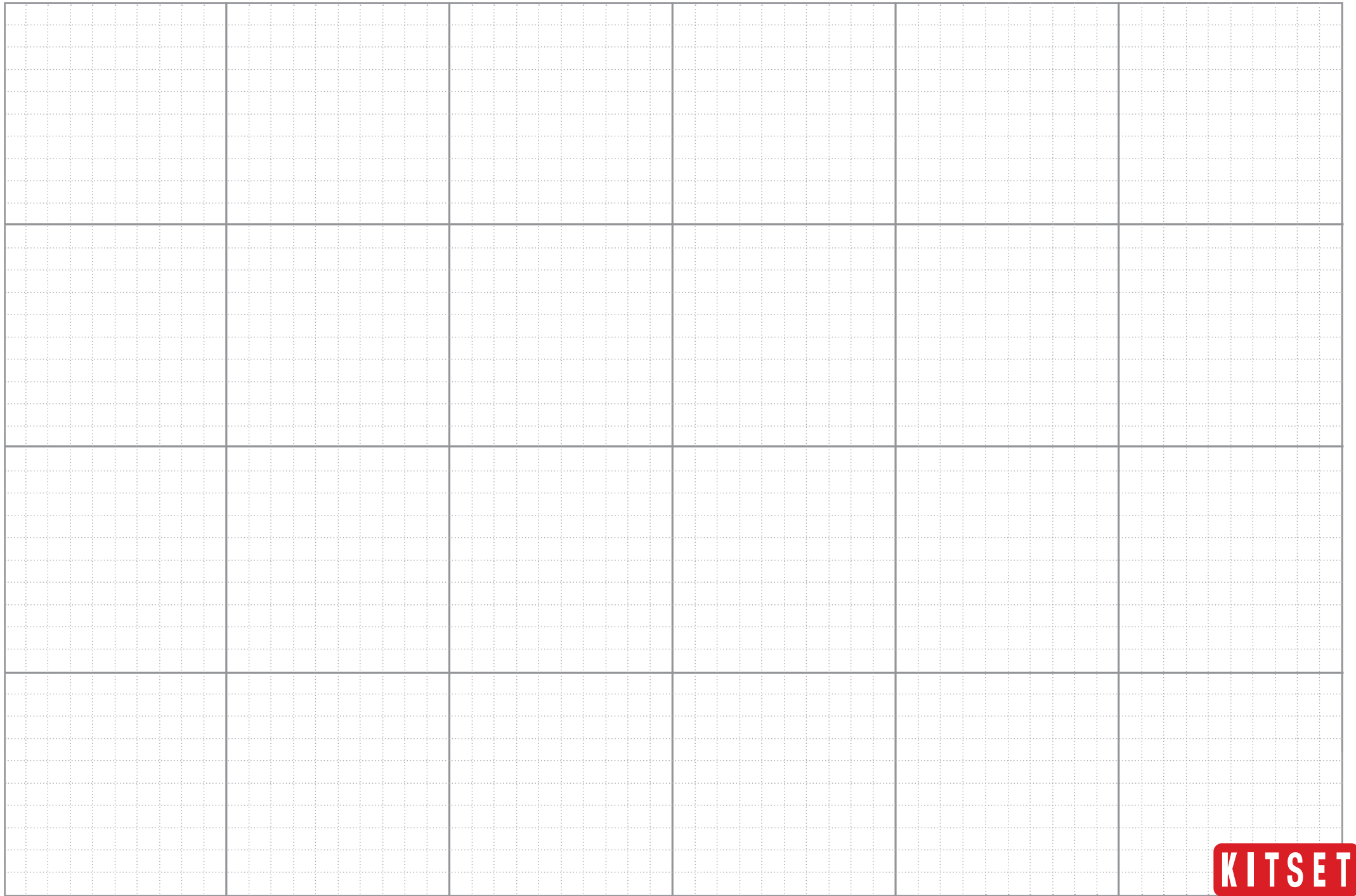

1 square on the graph paper = 10 cm 10 squares on the graph paper = 1 metre This planning guide remains the intellectual property of Kitset Kitchens. Not to be copied or duplicated without permission.

